

Authorised Distributors:-

ASH & ALAIN INDIA PVT LTD

S-100, F.I.E.E., Okhla Industrial Area, Phase-ii, New Delhi-110020(India)

Tel : 011-43797575 Fax : 011-43797574 E-mail : sales@ashalain.com



# Ultrasonic Displacement Sensor E4PA-N

Now, more advanced with a new mutual interference prevention function.



## Application Examples

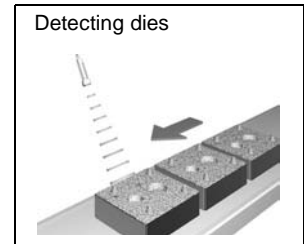
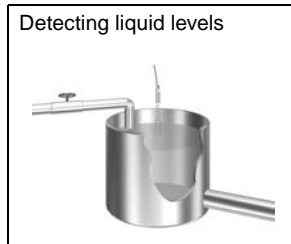
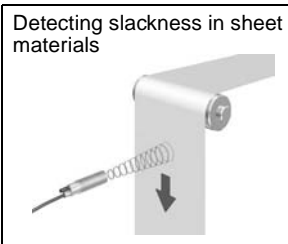

## Features

- High-precision detection with a wide range of measurements.

Four types of Sensors are available with maximum sensing distances of 0.5 m, 2 m, 4 m, and 6 m. With the 0.5-m type, a repeat accuracy of 1 mm or better has been achieved.

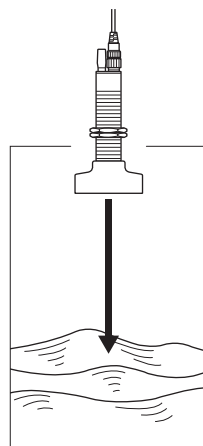

- A setting plug with a temperature compensation function makes it easy to set the sensing range.

The sensing range can be set by the Setting Plug, which is included with the Sensor. No special controller is required. The Setting Plug's built-in temperature sensor provides superior temperature characteristics of  $\pm 1\%$  FS.



- The Sensor is ultrasonic, so it is not affected by the color of objects.

A variety of materials can be measured, including transparent and reflective objects. Measurements are performed with no contact, so even highly-viscous liquids are no problem.

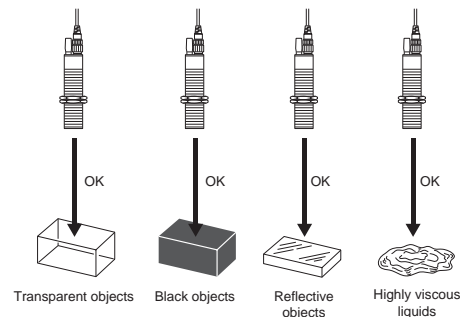

- The mutual interference prevention function allows up to five Sensors to be used in close proximity.

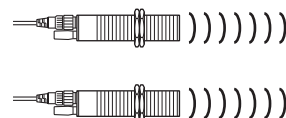



# Ordering Information

## ■ Sensors

Sensing range	Model
50 to 500 mm	E4PA-LS50-M1-N
120 to 2,000 mm	E4PA-LS200-M1-N
240 to 4,000 mm	E4PA-LS400-M1-N
400 to 6,000 mm	E4PA-LS600-M1-N

## ■ Accessories (Order Separately)

### Sensor I/O Connectors

Cable	Shape	Cable length		Model
Standard Cable	Straight 	2 m	5 conductors	XS2F-D521-DG0-A
		5 m		XS2F-D521-GG0-A
4-to-5 Conductor Conversion Cable (See note.)		0.3 m	---	E4PA-C01

**Note:** When you use a 4-pole sensor connector cable, the E4PA-C01 is useful for converting from 4 to 5 poles. If this is done, however, you cannot use the mutual interference prevention function.

### Setting Plug

Shape	Model	Remarks
	E4PA-P1	Attached to each Sensor

# Specifications

## ■ Ratings/Characteristics

Item	E4PA-LS50-M1-N	E4PA-LS200-M1-N	E4PA-LS400-M1-N	E4PA-LS600-M1-N
<b>Sensing range</b>	50 to 500 mm	120 to 2,000 mm	240 to 4,000 mm	400 to 6,000 mm
<b>Dead band distance</b>	0 to 50 mm	0 to 120 mm	0 to 240 mm	0 to 400 mm
<b>Standard sensing object</b>	100 × 100 mm flat plate			
<b>Applied frequency</b>	Approx. 380 kHz	Approx. 180 kHz	Approx. 85 kHz	Approx. 65 kHz
<b>Response time</b>	63 ms max.	195 ms max.	440 ms max.	850 ms max.
<b>Power supply voltage</b>	10 to 30 VDC; ripple (p-p): 10% max.			
<b>Power consumption</b>	1,800 mW max.			
<b>Analog output</b>	Current output: 4 to 20 mA (Allowable load resistance: 500 Ω max.) Voltage output: 0 to 10 V (1,000 Ω min.)			
<b>Mutual interference prevention cycle time</b>	10 ms	34 ms	77 ms	143 ms
<b>Linearity</b>	±1% FS max.			
<b>Repeat accuracy (See note.)</b>	0.1% FS max.			
<b>Temperature influence</b>	±1% FS of output value at +23°C in the temperature range of -10 to 55°C			
<b>Voltage influence</b>	±5% FS max. within rated power supply voltage range			
<b>Ambient temperature</b>	Operating: -10 to 55°C (with no icing or condensation) Storage: -40 to 85°C (with no icing or condensation)			
<b>Ambient humidity</b>	Operating and storage: 35% to 85% (with no condensation)			
<b>Insulation resistance</b>	50 MΩ min. (at 500 VDC) between current-carrying parts and case			
<b>Dielectric strength</b>	1,000 VAC (50/60 Hz) for 1 min between current-carrying parts and case			
<b>Vibration resistance</b>	Destruction: 10 to 55 Hz, 1-mm double amplitude for 2 hours each in X, Y, and Z directions			
<b>Shock resistance</b>	Destruction: 300 m/s <sup>2</sup> three times each in X, Y, and Z directions			
<b>Connection method</b>	5-conductor connector			
<b>Degree of protection</b>	1EC60529: IP65			
<b>Weight (packed)</b>	Approx. 240 g		Approx. 320 g	Approx. 400 g
<b>Materials</b>	Case: Stainless steel (SUS303) Sensing surface: PBT resin, polyurethane, glass epoxy resin			
<b>Accessories</b>	Operation Manual			

**Note:** Values are given one hour after power-up. The outputs may fluctuate due to external disturbances.

## Engineering Data

### ■ Sensing Distances (Typical Examples)

**E4PA-LS50-M1-N**

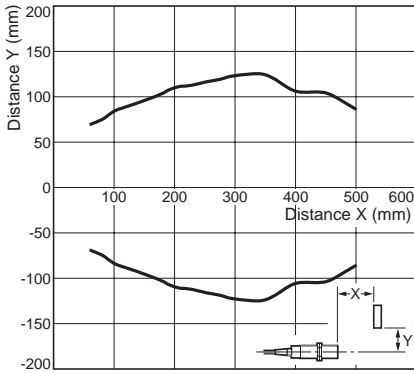

**E4PA-LS200-M1-N**

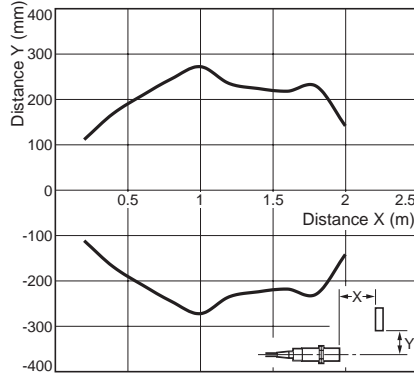

**E4PA-LS400-M1-N**

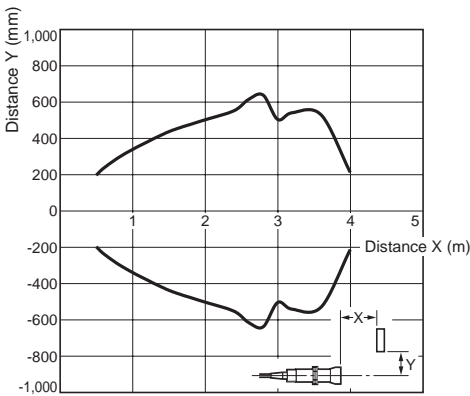

**E4PA-LS600-M1-N**

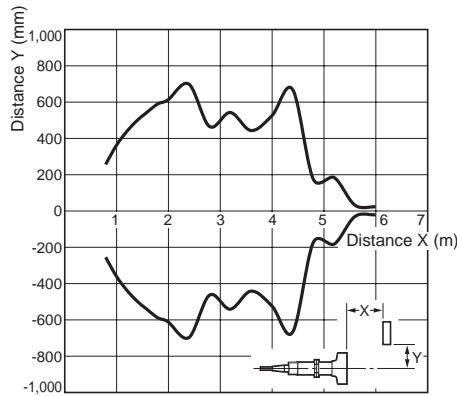

## Output Circuit

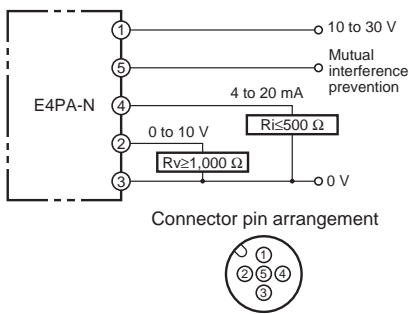

### Sensor I/O Connector

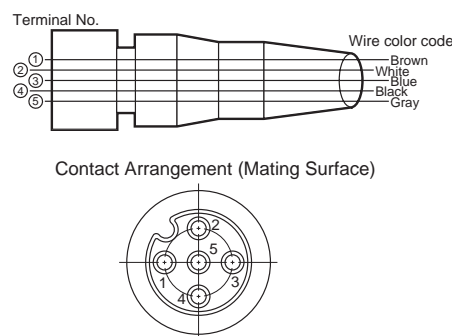

Class	Wire color code	Pin No.	Application
For DC	Brown	1	Power supply (+V)
	White	2	Voltage output
	Blue	3	Power supply (0 V)
	Black	4	Current output
	Gray	5	Mutual interference prevention input

# Nomenclature

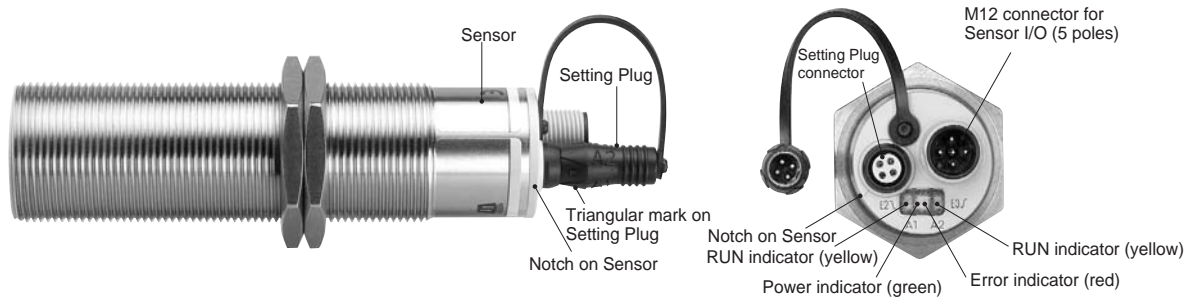

## Setting Plug

The E4PA-N is set up by aligning the notch on the Sensor with one of the triangular marks on the Setting Plug and inserting the Setting Plug into the Sensor.

Position	Function
A1	Nearest sensing point A1
A2	Farthest sensing point A2
E2/E3 (See note 1.)	Analog output characteristics <ol style="list-style-type: none"> <li>Increase: As the distance increases, the output increases. (LED A1 flash.)</li> <li>Decrease: As the distance increases, the output decreases. (LED A2 flash.)</li> <li>Output from 0 mm: Increases from the sensing surface to point A2. (LED A1 and A2 flash.) (See note 2.)</li> </ol>
T	Temperature compensation setting (normal operating condition)

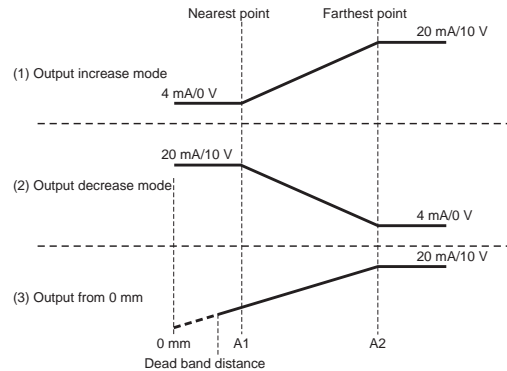

- Note:**
- Analog Output Characteristics when Setting Plug is inserted at E2/E3 Position:  
The analog output characteristics will change from (1) to (2) to (3), in that order, each time the Setting Plug is inserted with the E2/E3 position aligned with the notch on the Sensor.
  - The analog output value can be compensated so that the sensing surface (0 mm) of the Sensor is 4 mA/0 V regardless of the nearest sensing point setting.  
This function is useful when using Controllers without a scaling function. Sensing is not possible, however, for characteristics within the dead band distance and current/voltage output values may not be stable.

## Indicator Display and Analog Output Characteristics

Status		Setting Plug position	Power indicator (green)	Error indicator (red)	RUN indicator A1 (yellow)	RUN indicator A2 (yellow)	Analog output
Normal operation	Temperature compensation	T	Lit	Not lit	Lit/Not lit (See note 1.)	Lit/Not lit (See note 1.)	Present value
	Setting Plug not inserted		Not lit	Lit	Lit/Not lit (See note 1.)	Lit/Not lit (See note 1.)	Present value
	Malfunction sensing (when detecting external disturbance)		Not lit	Flashing	Lit/Not lit (See note 2.)	Lit/Not lit (See note 2.)	No change or unstable
Sensing distance A1 setting	With sensing object	A1	Flashing	Not lit	Flashing	Not lit	No change
	Without sensing object		Not lit	Flashing	Flashing	Not lit	No change
Sensing distance A2 setting	With sensing object	A2	Flashing	Not lit	Not lit	Flashing	No change
	Without sensing object		Not lit	Flashing	Not lit	Flashing	No change
Analog output characteristics setting	(1) Output increase mode	E2/E3	Lit	Not lit	Flashing	Not lit	No change
	(2) Output decrease mode		Lit	Not lit	Not lit	Flashing	No change
	(3) Output from 0 mm		Lit	Not lit	Flashing (synchronous)	Flashing (synchronous)	No change
Power turned ON		None	Flashing	Not lit	Previous status	Previous status	No change

- Note:**
- Lit: The sensing object is within the sensing range.  
Not lit: The sensing object is not within the sensing range.

- Output indicator just prior to occurrence of malfunction.

## Mutual Interference Prevention

The E4PA-N provides a sync input to prevent mutual interference. When the fifth pin of the Sensor I/O Connector's M12 Connector is interconnected, mutual interference can be prevented for up to five Units. The Sensors will mutually oscillate, however, causing a delay in measurement time by the mutual interference cycle time per Sensor × number of Units + response time. When the sync inputs are not connected, the mutual interference prevention function is disabled.

(For example, if three E4PA-LS200-M1-N are connected, the response time for one Sensor is 34 ms × 3 Sensors + 195 ms = 297 ms.



# Operation

## Setup and Operating Procedure

The E4PA-N is factory-set for the decrease mode for analog output characteristics and for the maximum sensing range. These settings enable scaling with the connected device (e.g., the K3NX). In this case, only step 4 is required.





To change the analog output range, follow steps 1 to 4 below.

### 1. Preparation for Setup

Step	Setting/Operation
1	Remove the Setting Plug. 
2	Turn ON the power. (See note.) 
3	Proceed to Step 2 <i>Setting Sensing Range</i> .

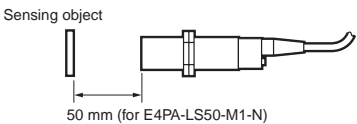
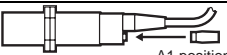
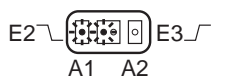
**Note:** Do not insert the Setting Plug yet. It must be inserted within five minutes after the power is turned ON, however, or the set-up will not be possible. If that happens, power up again and start over.

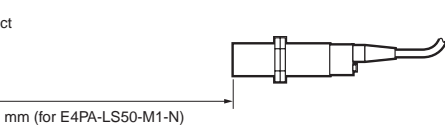
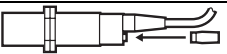
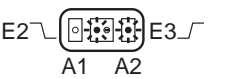
### 2. Setting Sensing Range

Step	Setting/Operation
1	Place the sensing object at the nearest point within the sensing range.  50 mm (for E4PA-LS50-M1-N)
2	Insert the Setting Plug at the A1 position. (Align the notch on the Sensor with the A1 triangular mark on the Setting Plug.) The power indicator (green) and the A1 RUN indicator (yellow) with flash, showing that the near distance has been correctly set.  A1 position  E2 A1 A2 E3
3	Remove the Setting Plug. (In this state, the setting is confirmed and recorded.) 
4	Place the sensing object at the farthest point within the sensing range.  500 mm (for E4PA-LS50-M1-N)
5	Insert the Setting Plug at the A2 position. (Align the notch on the Sensor with the A2 triangular mark on the Setting Plug.) The power indicator (green) and the A2 RUN indicator (yellow) will flash, showing that the far distance has been correctly set.  A2 position  E2 A1 A2 E3
6	Remove the Setting Plug. (In this state, the setting is confirmed and recorded.) 
7	Proceed to Step 3 <i>Setting Analog Output Characteristics Mode</i> .

**Note:** If the reflection from the Sensor is extremely weak, or if the sensing object is set outside of the sensing range, the error indicator (red) will flash to show that the sensing range is not accurately set. If the Setting Plug is left removed for five minutes or longer, temperature compensation will be disabled (status before setting).

If it becomes necessary to change the settings for step 2 (Sensing Range) or step 3 (Analog Output Characteristics Mode) after steps 1 through 4 have been completed, the contents of all the previous settings will be remembered, so only the items to be changed need to be reset. Go through the steps in order, from 1 to 4, and reset only the items to be changed.

### 3. Setting Analog Output Characteristics Mode

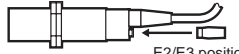
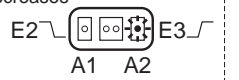
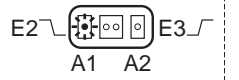
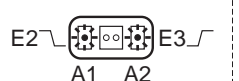
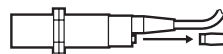
Step	Setting/Operation
1	Insert the Setting Plug at the E2/E3 position. (Align the notch on the Sensor with the E2/E3 triangular mark on the Setting Plug.)  E2/E3 position  A2 RUN indicator (yellow) flashing: ● Analog output characteristics: Decrease mode In this mode, the analog output decreases (20 to 4 mA/10 to 0 V) as the sensing object nears the E4PA within the sensing range.  E2 A1 A2 E3  The mode changes when the Setting Plug is reinserted at the E2/E3 position.  A1 RUN indicator (yellow) flashing: ● Analog output characteristics: Increase mode In this mode, the analog output increases (4 to 20 mA/0 to 10 V) as the sensing object nears the E4PA within the sensing range.  E2 A1 A2 E3  The mode changes when the Setting Plug is reinserted at the E2/E3 position.  A1 and A2 RUN indicators (yellow) flashing at the same time: ● Analog output characteristics: Output from 0 mm In this mode, the analog output decreases (20 to 4 mA/10 to 0 V) as the sensing object nears the E4PA between the farthest sensing point and 0 mm.  E2 A1 A2 E3  <b>Note:</b> Check the input impedance of connected devices and the analog output in <i>Ratings/Characteristics</i> (see page 2).  2 After the analog output characteristics have been set, remove the Setting Plug.   3 Proceed to Step 4 <i>Setting Temperature Compensation Mode</i> .

### 4. Setting Temperature Compensation Mode

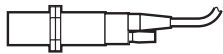
Step	Setting/Operation
1	Insert the Setting Plug at the T position. (Align the notch on the Sensor with the T triangular mark on the Setting Plug.)  T position
2	Leave the Setting Plug inserted where it is. (This completes the set-up.)   <b>Note:</b> To maintain the temperature compensation, leave the Setting Plug inserted during operation. If it is removed from the E4PA, the temperature compensation will be disabled.

# Safety Precautions

## ■ Precautions for Safe Use

### Design

#### Power Supply

If possible, use a power supply without overcurrent detection. This Sensor uses a DC-DC converter in the power supply circuit. If the power supply has overcurrent detection, the protective circuit may be activated by the inrush current.

Recommended power supply: OMRON S82-series Power Supply (Capacity: 15 W min.)

### Wiring

#### Power Supply Voltage

Do not exceed the operating voltage range. Using a higher voltage or using an AC power supply (100 VAC or more) for a DC Sensor can cause explosion or burning.

#### Faulty Wiring

Be careful not to make wiring mistakes such as reversing the power supply polarity. Faulty wiring can cause explosion or burning.

#### Operating Environment

Do not use the Sensor in an environment where inflammable or explosive gas is present.

### Others

- Do not attempt to disassemble, repair, or modify any Units. Any attempt to do so may result in malfunction, fire, or electric shock.
- Dispose of Sensors as industrial waste.

## ■ Precautions for Correct Use

### Design

#### Sensor Ambient Temperature and Humidity

The acoustic velocity generally fluctuates approximately 0.17% with each 1°C of temperature change. For example, if the ambient temperature increases from 20 to 40°C, then the acoustic velocity will increase by 3.5%. Moreover, the acoustic velocity will increase by 2% in dry air compared with air with 100% humidity. Test the environmental conditions where the Sensor will actually be used.

#### Mutual Interference

Separate the Sensors as specified in the following table when using two or more Sensors in close proximity to one another. The mutual interference prevention function can be used with up to five Sensors.

#### Parallel Arrangement

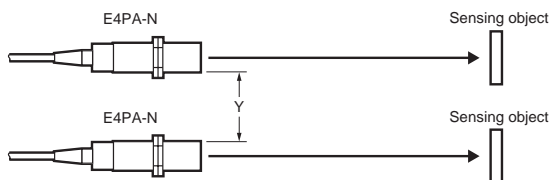

**Note:** The values shown in the following table are examples for reference only. The actual values will vary depending on the surface conditions of the sensing object, and on the ultrasonic waves that are reflected. Moreover, if the sensing object is inclined, the Y value in the table will be increased further.

Model	Y
E4PA-LS50-M1-N	0.3 m min.
E4PA-LS200-M1-N	1 m min.
E4PA-LS400-M1-N	2 m min.
E4PA-LS600-M1-N	2.5 m min.

#### Facing Arrangement

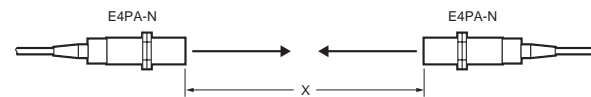

Model	Y
E4PA-LS50-M1-N	2 m min.
E4PA-LS200-M1-N	8 m min.
E4PA-LS400-M1-N	16 m min.
E4PA-LS600-M1-N	25 m min.

#### Sensing Object

- The sensing object may be solid, liquid, or powder, and the detection capability of the Sensor will vary depending on the surface conditions of the object. If the surface irregularities are no more than 0.2 mm, then the specified sensing distance will apply. Materials such as fine powder, felt, cotton, and other materials that absorb sound should be tested before using the Sensor.
- If the surface temperature of the sensing object is over 100°C, there will be very little ultrasonic reflection. Conduct tests before using the Sensor.

#### Influence of Sensing Angle

Ultrasonic Displacement Sensors can detect solid, liquid, or powder sensing objects, but the surface of the sensing object will affect the measurement. Dented surfaces or sensing objects with an angled surface require a tilt angle within 3° max. to achieve accurate sensing.



### Installation

#### Mounting the Sensor

The Sensor must be mounted using the nuts provided, and tightened to a torque of 15 N·m max.

If the Sensor malfunctions due to noise, insert insulation between the Sensor and the mounting base (metal).

#### Atmosphere

- To ensure reliability and long service life, do not use the Sensor outdoors or in places that exceed the rated temperature.
- Ultrasonic sensors use air as the transmission medium, so if there are local temperature differences there may be malfunctioning due to reflection and refraction at the boundaries, and the detection distances change where wind blows. Therefore, the Sensor should not be used near equipment such as forced-air ventilators.
- Jets from air nozzles include various frequencies, so they can affect the Sensor and should not be used nearby.
- Water drops on the Sensor surface shorten the sensing distance.

### Wiring Considerations

#### Cable Length

The cable must be no longer than 10 m.

#### High-voltage Lines

Do not lay power supply cable for the E4PA-N Ultrasonic Displacement Sensor together with high-voltage lines or power lines. Placing them in the same conduit or duct may result in interference, damage, or malfunction.

# Dimensions

Note: All units are in millimeters unless otherwise indicated.

## Sensors

### E4PA-LS50-M1-N

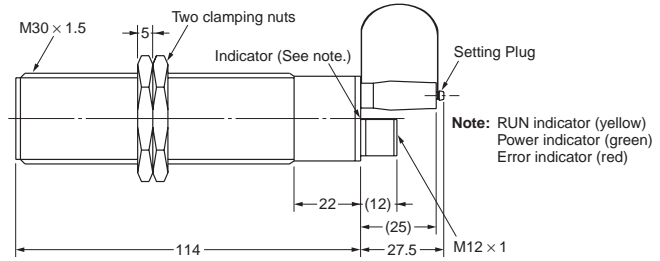
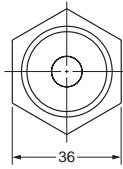

### E4PA-LS200-M1-N

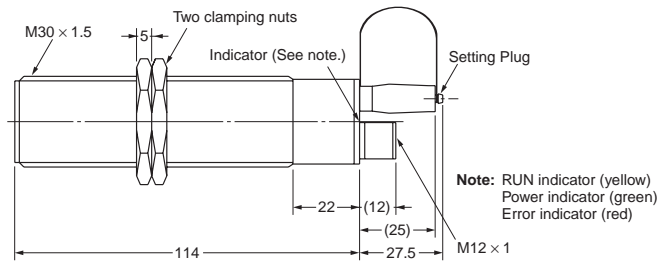
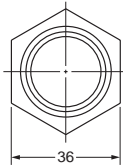

### E4PA-LS400-M1-N

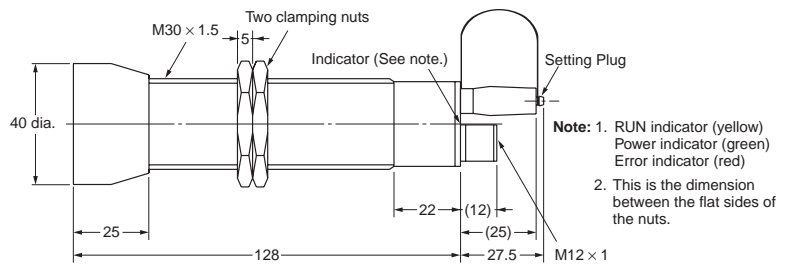
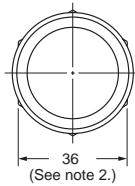

### E4PA-LS600-M1-N

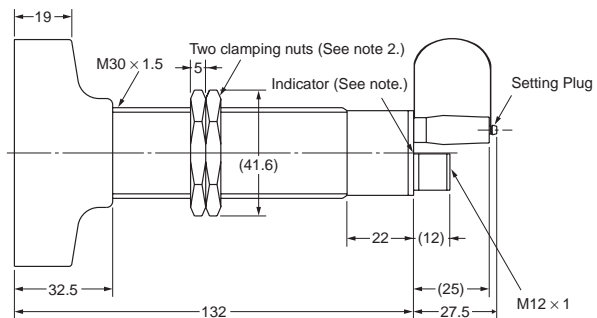
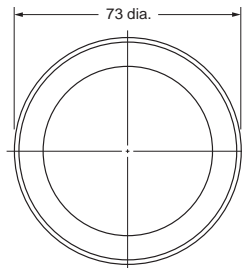

Note: 1. RUN indicator (yellow)  
Power indicator (green)  
Error indicator (red)

2. The distance between the flat sides of the nuts is 36 mm.

■ Accessories (Order Separately)

**Standard (Straight)**

XS2F-D521-DG0-A (L=2 m)  
 XS2F-D521-GG0-A (L=5 m)

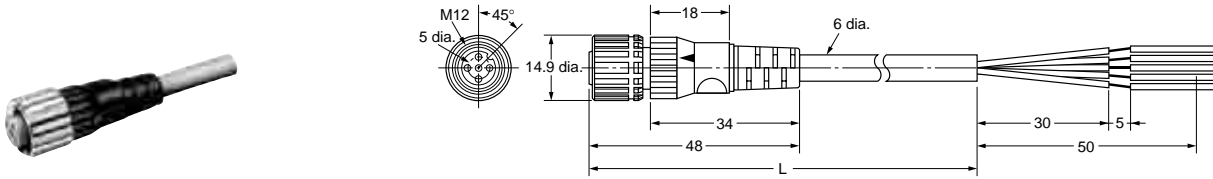

**4-to-5 Conductor Conversion Cable**

E4PA-C01

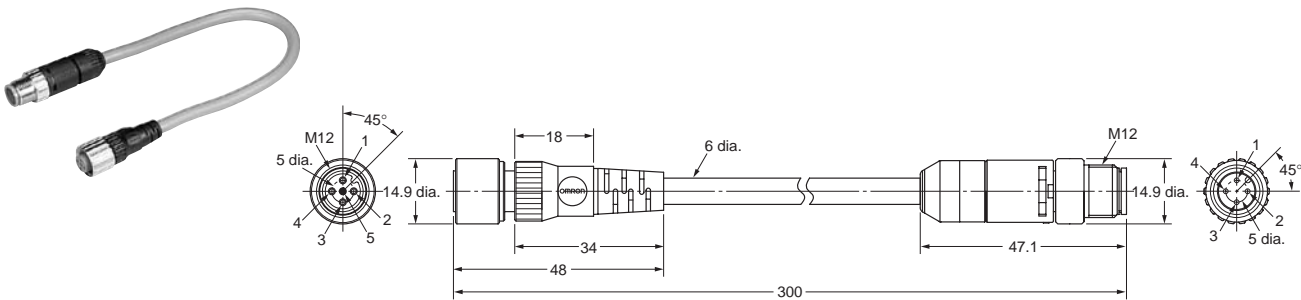

**Setting Plug**

E4PA-P1

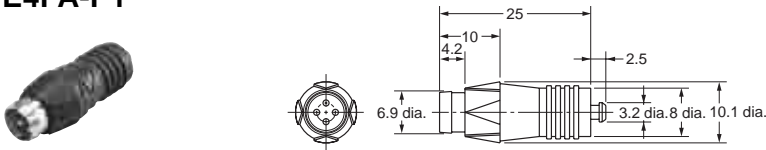

Authorised Distributors:-

ASH & ALAIN INDIA PVT LTD

S-100, F.I.E.E., Okhla Industrial Area, Phase-ii, New Delhi-110020(India)

Tel : 011-43797575 Fax : 011-43797574 E-mail : sales@ashalain.com

**ALL DIMENSIONS SHOWN ARE IN MILLIMETERS.**

To convert millimeters into inches, multiply by 0.03937. To convert grams into ounces, multiply by 0.03527.

Cat. No. D099-E1-01A In the interest of product improvement, specifications are subject to change without notice.

**OMRON Corporation**

Industrial Automation Company

Application Sensors Division  
 Sensing Devices and Components Division H.Q.  
 Shiokoji Horikawa, Shimogyo-ku,  
 Kyoto, 600-8530 Japan  
 Tel: (81)75-344-7068/Fax: (81)75-344-7107

0104 (0903)